

BLAZE™

Revolutionary High-Speed Cameras for Spectroscopy



Meet **BLAZE**™ The Next Generation of Spectroscopy Cameras



For close to four decades, Princeton Instruments has produced iconic cameras, spectrometers, and software — advanced scientific tools utilized daily by leading researchers and Nobel laureates around the world. Now we're pleased to introduce BLAZE spectroscopy CCD cameras.

Thanks to revolutionary new sensors with **up to 3x higher NIR sensitivity** and low dark current, there are no better cameras than BLAZE for demanding applications. BLAZE gives you blazing spectral rates **up to thousands of spectra per second**. For low-light applications, BLAZE delivers **TRUE -100°C cooling** for ultra-low dark current, ideal for long exposures. We believe no other scientific low-light spectroscopy camera can match BLAZE's performance and ease of use.

With BLAZE, spectroscopy will never be the same!

Applications include:

Raman Spectroscopy, Photoluminescence, Nanoparticle Research, Carbon Nanotube Studies, Pump-Probe Experiments, Fluorescence, Micro-spectroscopy



SUPER SENSITIVE

Up to 75% QE @ 1000 nm



BLAZING FAST

Dual 16 MHz Readouts



DEEPEST COOLING

TRUE -100°C

BLAZE is sensitive. Two proprietary new sensors offer BLAZE users unrivaled performance for spectroscopy applications.

HR-Sensors offer higher quantum efficiency in the NIR than any other spectroscopic devices. With our patented eXcelon process, HR-Sensors offer high quantum efficiency from visible to NIR, with QE above 90% at 450nm, 98% at 900nm and 75% at 1000nm.

LD-Sensors, meanwhile, are back-illuminated, deep-depletion devices designed to minimize dark current. These CCDs are ideal for the long exposures required by low-light applications.

BLAZE is fast. ADC readout speeds 10-15x higher than previous cameras allow BLAZE to capture spectral data at unparalleled spectral rates. With full vertical binning, these exceptional cameras can operate at spectral rates greater than 1 kHz. Even higher spectral rates are achievable with custom binning or kinetics operations.

Additionally, unique bi-directional clocking enables BLAZE users to utilize the camera's **new SeNsR™ operating mode** for low-light applications. This exclusive technology is described in more detail on page 3.

BLAZE is cool. No other camera comes close to the thermoelectric cooling capabilities of BLAZE. BLAZE incorporates state-of-the-art **ArcTec™** cooling technology, capable of operation down to **TRUE -100°C**. Other manufacturers claim deep cooling, but BLAZE is the only camera that achieves -95°C cooling in air and **TRUE -100°C** with 20°C liquid. This deep cooling ability allows BLAZE to operate with extremely low dark current, ideal for long-exposure requirements. Unlike competitive cameras, BLAZE only requires the use of (near room temperature) 20°C liquid to achieve -100°C, so you don't have to worry about any damaging condensation.

Princeton Instruments' new, low-noise BLAZE™ CCD cameras are the most advanced high-sensitivity, ultra-fast, deep-cooled spectroscopic detectors available.

Key Camera Features:

- ▶ Two proprietary new sensors: HR-Sensors and LD-Sensors
- ▶ HR-Sensors: unmatched NIR quantum efficiency (up to 75% @ 1000 nm)
- ▶ LD-Sensors: inverted-mode, deep-depletion sensors with low dark current for excellent broadband performance and improved NIR response
- ▶ With our patented eXcelon process, both HR and LD sensors offers unrivaled QE from visible to NIR region.
- ▶ Exclusive new SeNsR technology allows rapid control and charge shifting on the sensor to enhance pump-probe experiments and increase signal-to-noise performance of the system.
- ▶ High speed: spectral rates greater than 1 kHz full vertical binning
- ▶ ADC readout speeds 10-15x higher than conventional spectroscopy CCD cameras
- ▶ Exclusive ArcTec technology cools the sensor to -95°C in air (without chillers or cryocoolers). Cools to **TRUE -100°C** (with 20°C liquid assist). Absolutely no condensation.
- ▶ Cooling design features all-metal seals backed by a permanent vacuum guarantee.
- ▶ A high-speed USB 3.0 data interface with an optional fiberoptic connection supports remote operation.
- ▶ BLAZE is compatible with Princeton Instruments IsoPlane[®], SpectraPro[®], and SpectraPro HRS spectrographs.
- ▶ BLAZE is fully supported by 64-bit Princeton Instruments LightField[®] software.



Advanced new SeNsR technology

Thanks to its unique bi-directional clocking ability, BLAZE offers a new SeNsR operating mode for low-light applications. With SeNsR, it is now possible to rapidly shift the charge (i.e., signal) on the CCD without reading out the data.

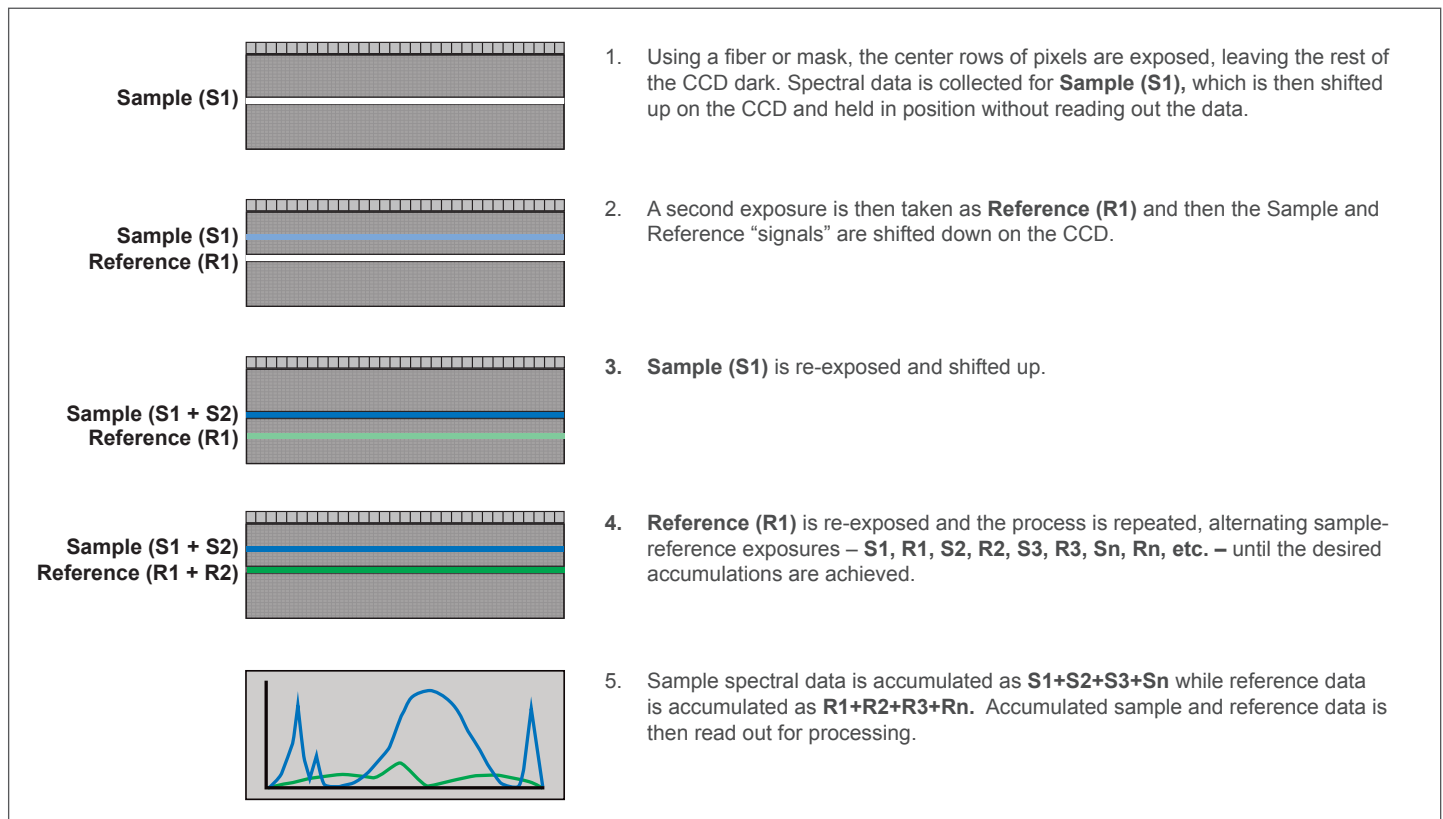

Exclusive New Sensor Technologies



Two revolutionary new sensors were developed for BLAZE, making it the ideal spectroscopy camera. HR-Sensors are super-deep-depletion devices that offer the highest NIR quantum efficiency of any spectroscopic CCD. LD-Sensors are deep-depletion devices designed for extremely low dark current, allowing long exposures in demanding spectroscopic applications.

Proprietary new HR-Sensors

This new generation of sensors provides the highest NIR performance of any spectroscopic CCDs available.

HR-Sensors feature a thick depletion region of high-resistivity bulk silicon to deliver up to 75% quantum efficiency at 1000 nm, making them especially desirable for light detection in the wavelength region between traditional CCDs' and InGaAs detectors' sensitivity ranges (i.e., typically 800 to 1100 nm).

Spatial resolution is optimized by applying a bias voltage, resulting in a "fully depleted" silicon region with no diffusion of charge. The bias voltage generates an electric field that pushes the charge toward the correct pixels and does not allow charge to migrate to adjacent pixels

Back-Illuminated Super-Deep-Depletion HR-Sensors

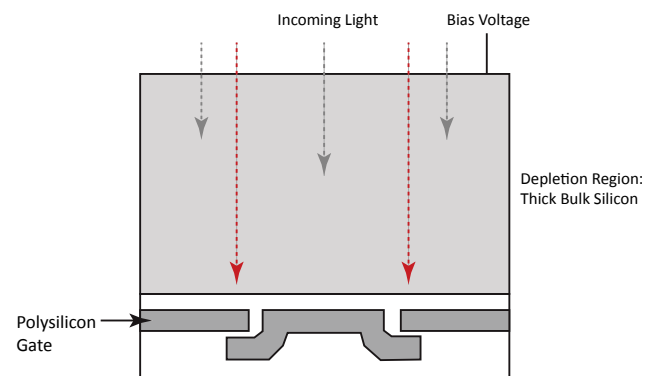

Proprietary new LD-Sensors

Back-illuminated deep depletion CCDs were developed for enhanced quantum efficiency at NIR wavelengths. eXcelon technology boosts performance even further, delivering high average QE from UV to NIR wavelengths with negligible etaloning.

LD-Sensors are a new generation of advanced deep-depletion devices that run in inverted mode, resulting in very low dark current with excellent broadband performance and improved NIR quantum efficiency.

Back-Illuminated Deep-Depletion LD-Sensors

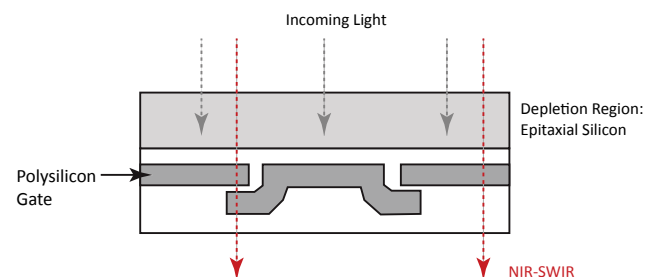

eXcelon

eXcelon is a sensor process which radically improves the sensitivity of back-illuminated CCD detectors across a wide spectral range. Excelon also significantly reduces etaloning – the problematic appearance of fringes caused by constructive and destructive interference in backilluminated sensors – while imaging in the 750 – 1100 nm range (NIR).

Exceptional Sensor Quantum Efficiency

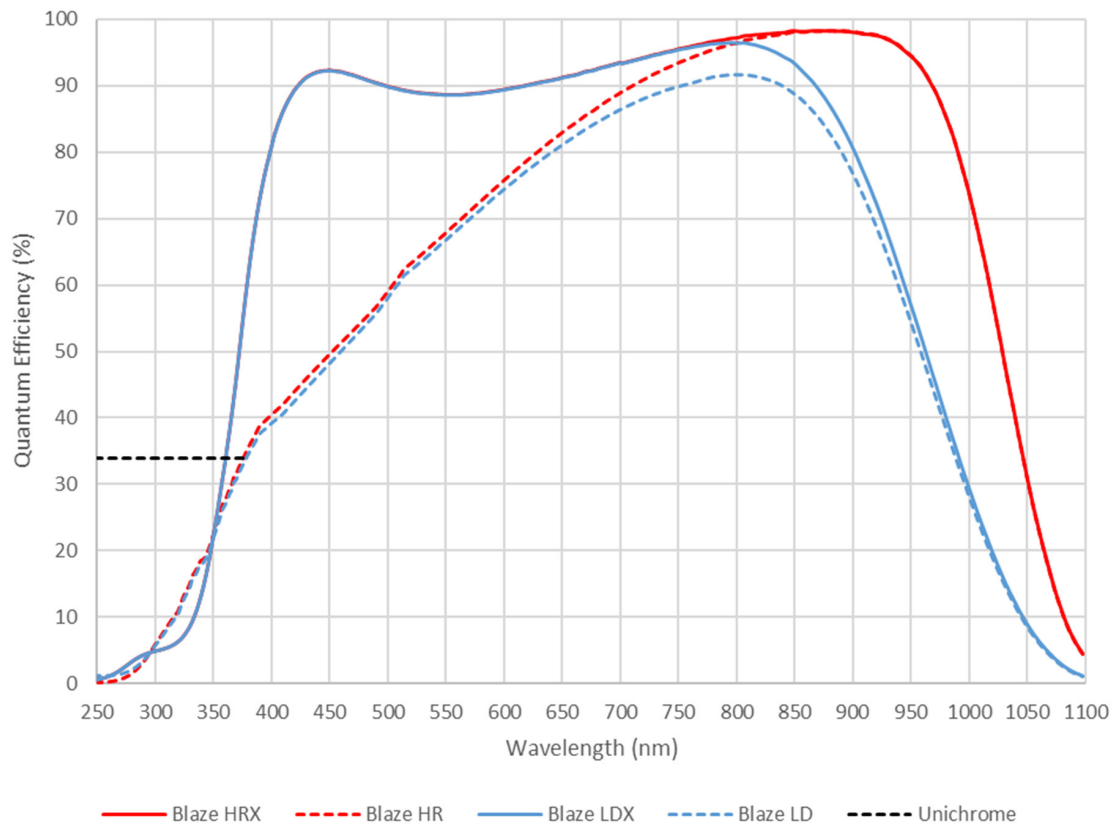

Graph shows typical QE data measured at 25°C. QE decreases at normal operating temperatures. For the best results for your application, please discuss the specific parameters of your experiment with your sales representative.

BLAZE camera on a Princeton Instruments IsoPlane-160



The Art of Being Cool

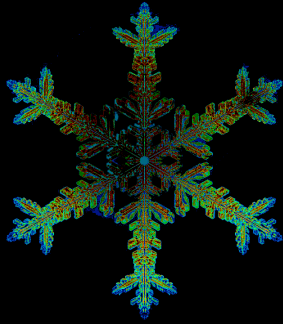

BLAZE cameras utilize proprietary ArcTec technology, the most advanced cooling design available for spectroscopic CCDs. **TRUE -100°C cooling** of a CCD without liquid nitrogen requires extensive knowledge of thermodynamics, computational fluid dynamics, and ultra-high vacuum (UHV) environments. ArcTec includes custom-designed Peltier devices, advanced multi-stage thermoelectric cooling, and permanent all-metal UHV seals to achieve unprecedented CCD cooling.



Never sweat it.

BLAZE cameras cool CCDs down to -95°C in air without chillers or liquid assist and can achieve **TRUE -100°C cooling** using near room temperature (i.e., 20°C) liquid assist. By contrast, competitive cameras claim -100°C operation; however, this requires 10°C chilled liquid and creates the very real possibility of harmful condensation forming inside the cameras that can ultimately compromise the ability to cool their sensors. The colder CCD temperatures achieved by BLAZE cameras result in lower dark current, allowing longer exposure times and superior low-light detection capabilities.

Please refer to our ArcTec Technical Note for more information.



BLAZE cooling summary:

- ▶ Multi-stage thermoelectric cooling with custom-designed Peltier devices for unprecedented cooling capabilities
- ▶ Permanent all-metal UHV seals for reliable long-term operation
- ▶ Ability to operate at -95°C without chillers or liquid assist
- ▶ Ability to reach -100°C with 20°C liquid assist

Air cooling

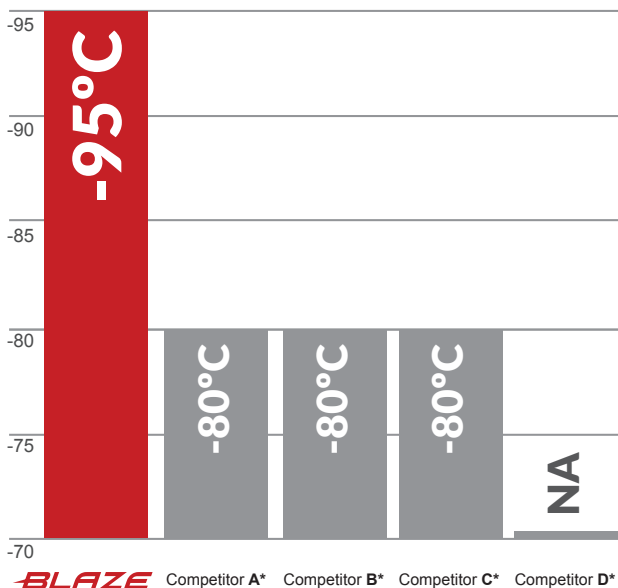

Liquid assist (required for maximum cooling)

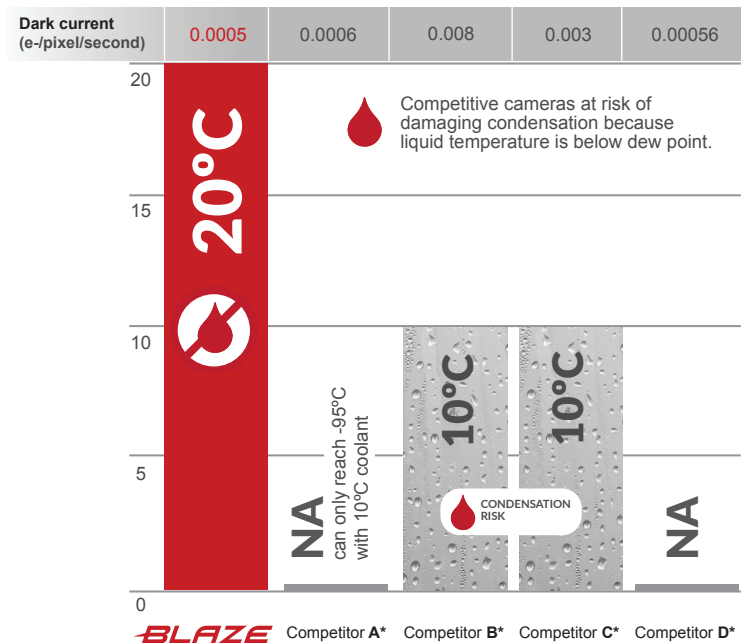

* Competitive cameras require an extremely dry environment ($\leq 43\%$ relative humidity) to achieve their coldest operating temperatures! Otherwise their cooling capability is limited.

Specifications

	BLAZE 100-HR	BLAZE 100-HRX	BLAZE 400-HR	BLAZE 400-HRX	BLAZE 100-LD	BLAZE 100-LDX	BLAZE 400-LD	BLAZE 400-LDX
Sensor	Exclusive Back-Illuminated Fully Depleted High-Resistivity-Silicon HR-Sensor (highest NIR quantum efficiency, includes anti-fringing coating)				Exclusive Back-Illuminated IMO Deep-Depletion LD-Sensor (low dark current with anti-fringing coating)			
Active area (L x W, pixels)	1340 x 100		1340 x 400		1340 x 100		1340 x 400	
Pixel size	20 x 20 μ m							
Image area	26.8 mm x 2.0 mm		26.8 mm x 8.0 mm		26.8 mm x 2.0 mm		26.8 mm x 8.0 mm	
Air cooled, no liquid assist	-95°C							
20°C liquid assist	-100°C							
Thermostatic precision	+/- 0.05°C							
Vertical clock speeds	4, 8, 10, 20 μ s/row (software selectable)							
Maximum spectra per second*	Full Vertical Binning: 1,650 Cropped Mode, 10 rows: 3,500 Kinetics Mode, 1 row: up to 250 kHz		Full Vertical Binning: 577 Cropped Mode, 10 rows: 1,366 Kinetics Mode, 1 row: up to 250 kHz		Full Vertical Binning: 1,260 Cropped Mode, 10 rows: 2,675 Kinetics Mode, 1 row: up to 250 kHz		Full Vertical Binning: 488 Cropped Mode, 10 rows: 2,675 Kinetics Mode, 1 row: up to 250 kHz	
Full frame rate*	218		37		140		35	
Dark current (typical @ max. cooling)	0.0015 e-/pix/sec				0.0005 e-/pix/sec			
ADC speeds	Low Noise: 2 x 100 kHz, 2 x 1 MHz, 2 x 4 MHz High Speed: 2 x 5 MHz, 2 x 10 MHz, 2 x 16 MHz				Low Noise: 2 x 100 kHz, 2 x 1 MHz, 2 x 5 MHz High Speed: 2 x 6.25 MHz, 2 x 8.33 MHz, 2 x 10 MHz			
System read noise	≤ 3 e- @ 100 kHz ≤ 10 e- @ 1 MHz				≤ 2.5 e- @ 100 kHz ≤ 8 e- @ 1 MHz			
Readout modes	Full Frame, Cropped, Bi-Directional, Kinetics							
Full well capacity	128 ke-				180 ke-			
Linearity	$\geq 99\%$							
Digitization	16 bits							
Data interface	USB 3.0							
Certification	CE, UL/CSA, FCC Part 15, VCCI (Japan), BSMI (Taiwan), KN32 & KN35 (Korea), AS/NZS (Australia, New Zealand)							
I/O signals	Trigger In, TTL Out, Readout Monitor, Expose Monitor, Shutter Monitor, External Shutter Control							

* 4 μ s vertical clock speed; HR-Sensor cameras: 2 x 16 MHz; LD-Sensor cameras: 2 x 10 MHz

Specifications are typical and subject to change without notice.

Readout rates

Spectral rates

2 ports	
16 MHz	1,650
10 MHz	1,260
5 MHz	1,095
4 MHz	990
1 MHz	680
100 kHz	133

Frame rates

2 ports	
16 MHz	218
10 MHz	140
5 MHz	70
4 MHz	57
1 MHz	14.8
100 kHz	1.5

Specifications

	BLAZE 100-B	BLAZE 400-B
Sensor	Exclusive Back-Illuminated Silicon Sensor with anti-fringing	
Active area (L x W, pixels)	1340 x 100	1340 x 400
Pixel size	20 x 20 μm	
Image area	26.8 x 2.0 mm	26.8 x 8.0 mm
Air cooled, no liquid assist	-95°C	
20°C liquid assist	-100°C	
Thermostatic precision	+/- 0.05°C	
Vertical clock speeds	4, 8, 10, 20 $\mu\text{s}/\text{row}$ (software selectable)	
Maximum spectra persecond*	Full vertical binning: 1,650 Cropped mode, 10 rows: 3,500 Kinetics mode, 1 row: up to 250 kHz	Full vertical binning: 412 Cropped mode, 10 rows: 3,500 Kinetics mode, 1 row: up to 250 kHz
Full frame rate*	218	54
Dark current (typical @ max. cooling)	0.0003 e-/pix/sec	
ADC speeds	Low Noise: 2 x 100 kHz, 2 x 1 MHz, 2 x 5 MHz High Speed: 2 x 6.25 MHz, 2 x 10 MHz, 2 x 16 MHz	
System read noise	≤ 3 e- @ 100 kHz ≤ 10 e- @ 1 MHz	
Readout modes	Full Frame, Cropped, Bi-Directional, Kinetics	
Full well capacity	200 ke-	
Linearity	$\geq 99\%$	
Digitization	16 bits	
Data interface	USB 3.0	
Certification	CE, UL/CSA, FCC Part 15, VCCI (Japan), BSMI (Taiwan), KN32 & KN35 (Korea), AS/NZS (Australia, New Zealand)	
I/O signals	Trigger In, TTL Out, Readout Monitor, Expose Monitor, Shutter Monitor, External Shutter Control	

* 4 μs vertical clock speed; HR-Sensor cameras: 2 x 16 MHz; LD-Sensor cameras: 2 x 10 MHz

Specifications are typical and subject to change without notice.

Readout rates

Spectral rates

2 ports	
16 MHz	1,650
10 MHz	1,260
5 MHz	1,095
4 MHz	990
1 MHz	680
100 kHz	133

Frame rates

2 ports	
16 MHz	218
10 MHz	140
5 MHz	70
4 MHz	57
1 MHz	14.8
100 kHz	1.5

LightField Software

The combination of LightField, BLAZE, and Princeton Instruments spectrographs provides researchers with the most advanced and reliable toolset for experimental setup, data acquisition, and post processing of spectroscopic data.

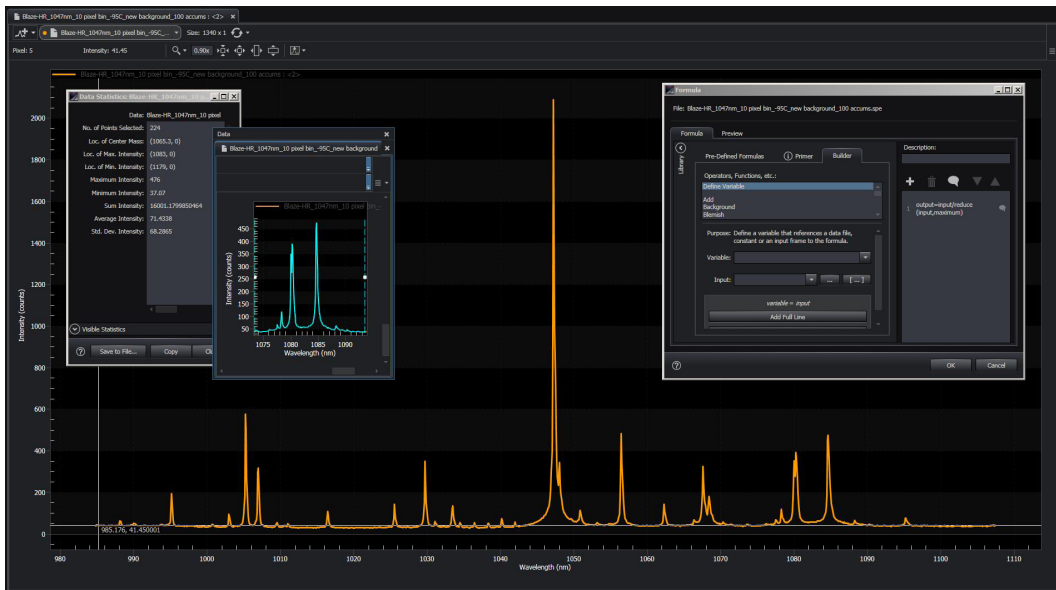

- ▶ Powerful 64-bit software package with Microsoft® Windows® 10 support
- ▶ Complete control of Princeton Instruments cameras and spectrometers
- ▶ Dependable data integrity via automatic saving to disk, time stamping, and retention of both raw and corrected data
- ▶ Seamless integration of new SeNsR technology
- ▶ Seamless integration with ResXtreme™ spectral deconvolution add-ins for SpectraPro HRS spectrographs
- ▶ For multi-user facilities, LightField can remember each user's experimental configuration
- ▶ LightField Math allows simple to complex math functions to be applied to live or stored data, along with an easy-to-use editor to create your own formulas
- ▶ Integrated LabVIEW® (National Instruments) and MATLAB® (MathWorks) support



- ▶ Exports to your favorite file formats, including TIFF, FITS, ASCII, AVI, IGOR, and Origin
- ▶ Live data processing operations provide real-time evaluation of incoming data to optimize experimental parameters



Outline Drawings

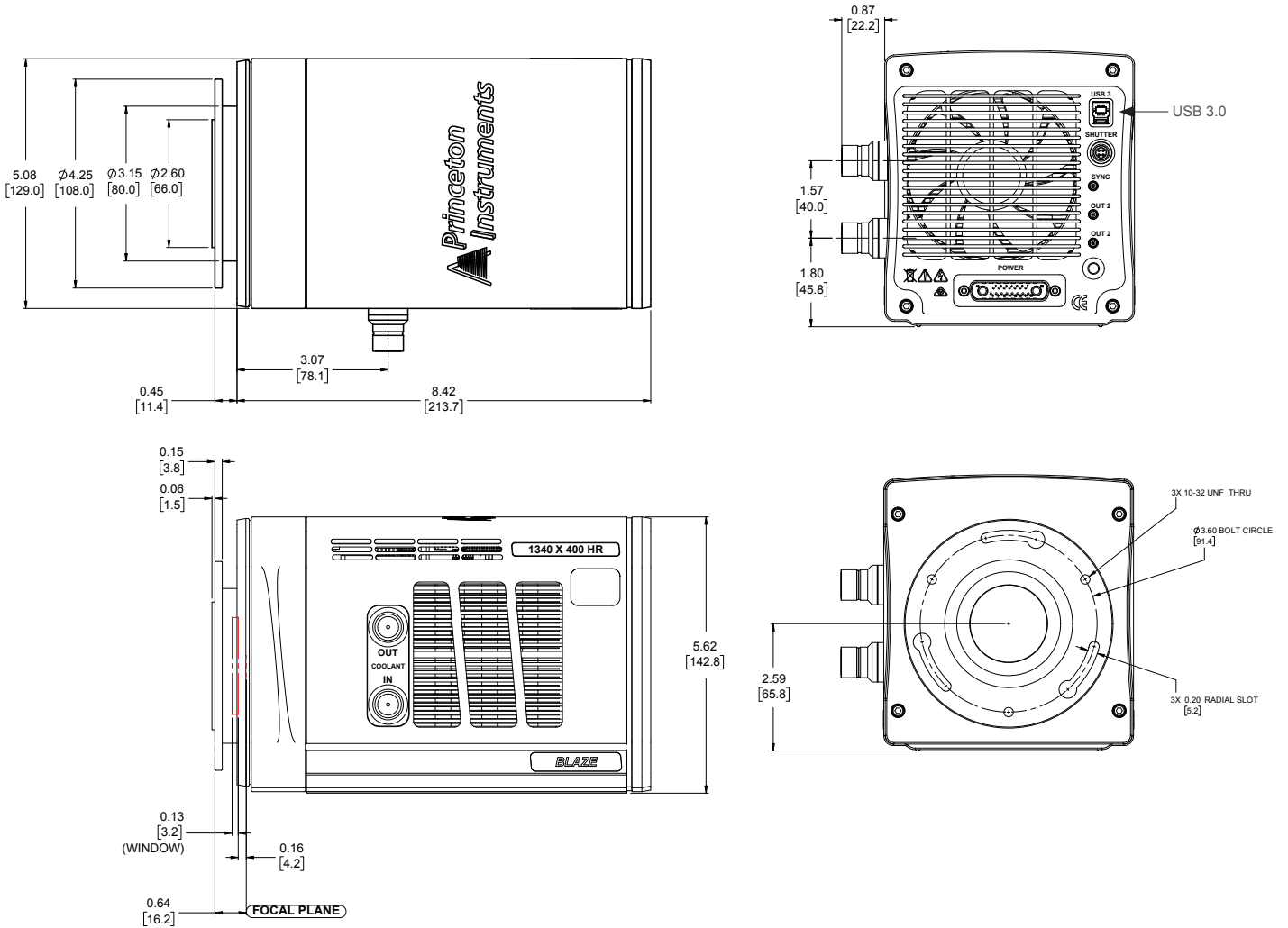

Vacuum Window AR Coatings (optional)

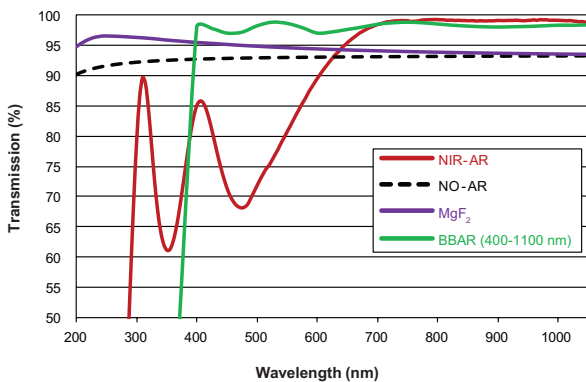

Notes:

- ▶ Standard anti-reflection (AR) coating options are shown on graph
- ▶ Designed by Acton Optics, our BBAR coating offers unmatched performance for range from 400 nm to 1100 nm
- ▶ Custom wedge window options and other AR coatings are also available

Contact your local sales representative for more information.

How To Order **BLAZE**

Cameras



Model Numbers:
 BLAZE 100HR
 BLAZE 400HR
 BLAZE 100HRX
 BLAZE 400HRX



Model Numbers:
 BLAZE 100BR LD
 BLAZE 400BR LD
 BLAZE 100BR-LDX
 BLAZE 400BR-LDX

Options

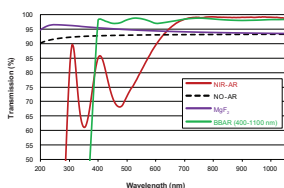

Unichrome: enhanced UV response for BLAZE cameras

Vacuum Window Coatings: anti-reflection coatings for BLAZE cameras (see page 10)

CoolCUBE II: for liquid-cooled operation of BLAZE cameras

LightField: powerful 64-bit software for imaging and spectroscopy (see page 9)

Other Spectroscopy Products

Princeton Instruments offers a broad range of state-of-the-art spectrographs and cameras for spectroscopy.

Spectrographs:



IsoPlane:
award-winning imaging spectrographs



SpectraPro HRS Series:
new multi-port spectrographs



LS-785:
high throughput, f/2 lens spectrograph



IsoPlane® 81:
complete, compact, and easy-to-use spectroscopy system

Cameras:



PIXIS: best-selling CCD cameras



PyLoN®: LN-cooled, low-dark-current cameras



PyLoN-IR: linear InGaAs arrays



ProEM®: EMCCD cameras



PI-MAX®4: fastest ICCD cameras



NIRvana®: 2D InGaAs cameras



KURO™: back-illuminated sCMOS cameras

Need help?

Send a message to info@princetoninstruments.com and a friendly Princeton Instruments representative will be in touch with you shortly.

BLAZE™

Revolutionary High-Speed Cameras for Spectroscopy

Contact your local Teledyne Princeton Instruments representative for additional information.

**Teledyne Princeton Instruments
Main Office- (USA)**

Tel: +1 609.587.9797
pi.info@teledyne.com

China

Tel: +86 157 2153 5343
pi.info.china@teledyne.com

France

Tel: +33.1.70.38.19.00
EVR@teledyne.com

Germany

Tel: + 49 (0) 89-660 779 3
pi.germany@teledyne.com

Japan

Tel: +81.3.6709.0631
PI.Nippon@teledyne.com

United Kingdom

Tel: +44 (0) 7810 835 719
pi.info@teledyne.com

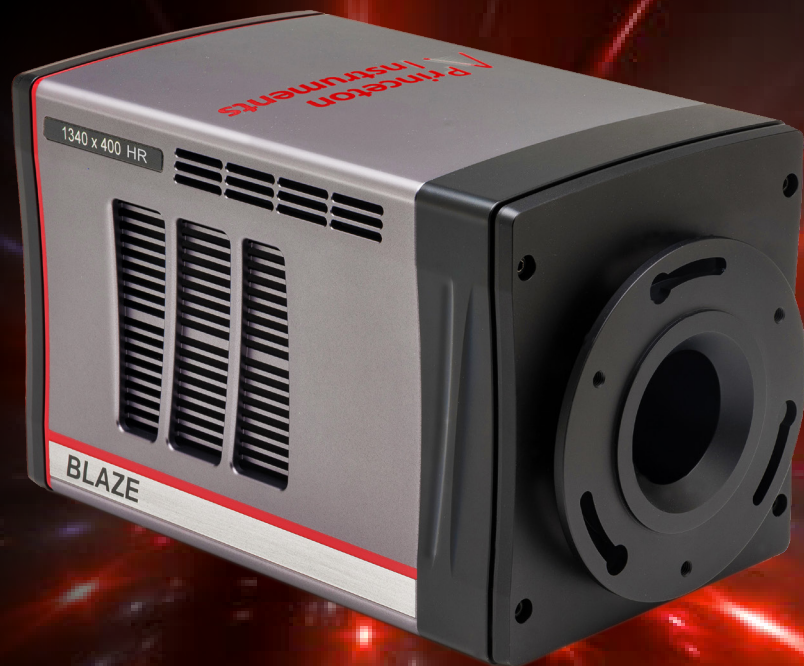

revA6

Copyright © 2017 Princeton Instruments, Inc. All rights reserved. ArcTec, BLAZE, FERGIE, KURO, ResXtreme, and SeNsR are trademarks and IsoPlane, LightField, NIRvana, PI-MAX, ProEM, PyLoN, and SpectraPro are registered trademarks of Princeton Instruments, Inc. Microsoft and Windows are registered trademarks of Microsoft Corporation in the United States and other countries. All other brand and product names are the trademarks or registered trademarks of their respective owners and manufacturers.